

## UV curing in inert atmospheric conditions

Increasing productivity in package printing, coating and release silicone coating

### System-Features

- Residual oxygen control < 30 ppm possible
- Nitrogen volume control by residual oxygen measuring device
- Low nitrogen consumption
- Low temperature load

### Advantages

- Increased productivity
- Improved surface quality
- Energy savings
- Processing of temperature sensitive materials

## UV curing in inert atmospheric conditions

The Hönle Group has access to a wealth of experience within the field of inert curing technology. We use this experience and optimize each inert installation according to our customers' requirements. So our customers benefit from outstanding product quality with optimized investment and operational expenses. The established product line of Hönle UV curing equipment works at arc lengths between 60 mm and 2600 mm, with power control from 20% up to 100% and is available with all standard and many non standard spectra.

### Operational principle of inert technology

The principle of UV curing technology is based on the radical formation of photo initiators by the impact of UV irradiation. These free radicals are able to split the double bonds of the binder vehicle and start the polymerization process. The presence of oxygen can obstruct the radical formation and the chain propagation illustrated below. Instead forming long polymer chains, the radicals of the photoinitiators and monomers react prematurely with the O<sub>2</sub> molecules, whereby the cross linking breaks off.

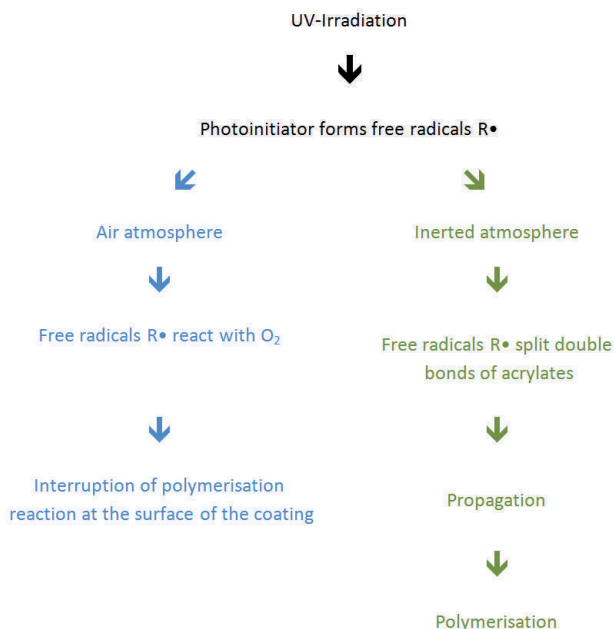

At the inertization process the oxygen (O<sub>2</sub>) in the irradiated area is displaced by an inert gas, usually nitrogen (N<sub>2</sub>).

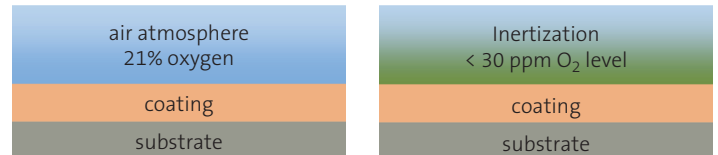

The positive effects of inertization on the production process are various:

- excellent surface curing and outstanding characteristics
- complete curing by precipitation, no post-curing
- even „problematic colours“ like full surface white can cured at high speeds
- cost savings through lower photo initiator levels within the UV inks and varnishes
- less migration because of significantly lower amounts of photo initiator and high cross-linking levels
- less UV irradiation and increased production speed
- reduced ozone production
- smell reduction
- less yellowing

Principle structure of inerted UV systems

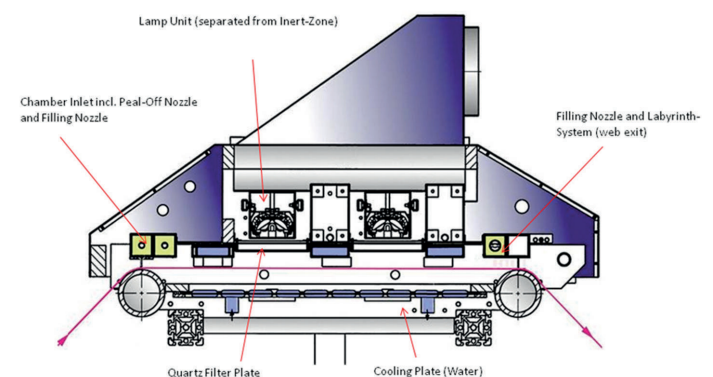

## Monitoring of the oxygen proportion

Usually Nitrogen ( $N_2$ ) is used as the inert gas, which is fed by pipes from a tank directly into the inert chamber of the UV facility. To ensure constant process conditions and a continuous quality level, monitoring of the remaining oxygen within the inert chamber is recommended. In this case the gas filling of the inert chamber is controlled and optimized by constant gas regulation. Automatic regulation takes into consideration the adherence of the remaining oxygen limits as well as economic optimization.

The maximum remaining amount of oxygen depends therefore on the requirements of the chemistry and can be different depending on the application. For example, radical curing silicones for release coatings require an oxygen maximum of  $< 30$  ppm and make high demands on the system and also because of the extremely high process speed.

With other applications the inerting level can be within a %-range, which keeps investment costs and  $N_2$  consumption costs under control and leads to an economic inertization process.

## Application examples:

Application:	coating, finishing, printing
Oxygen level:	$< 30$ ppm
UV lamps:	number, width and output depend on respective application
UV monitoring:	online monitoring optional
Inertization process:	Nitrogen ( $N_2$ ) with automated control of gas supply depending on oxygen concentration

## Plant design for horizontal respectively vertical pass

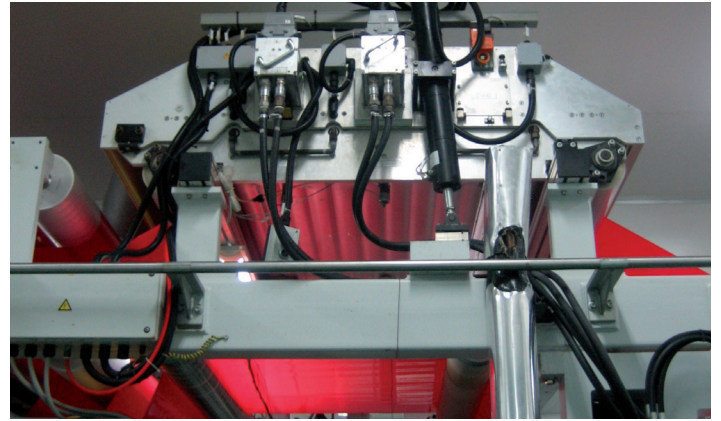

Example for Siliconization:  $< 30$  ppm remaining oxygen level,  $2 \times 200$  W/cm, 400 m/min

## Plant design on water chilled drum

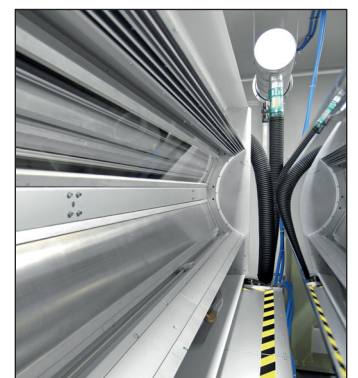
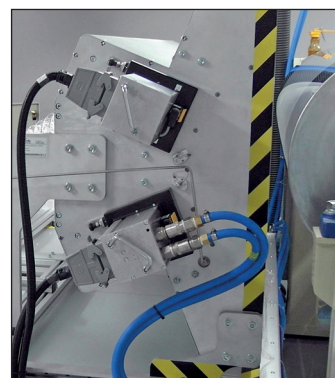
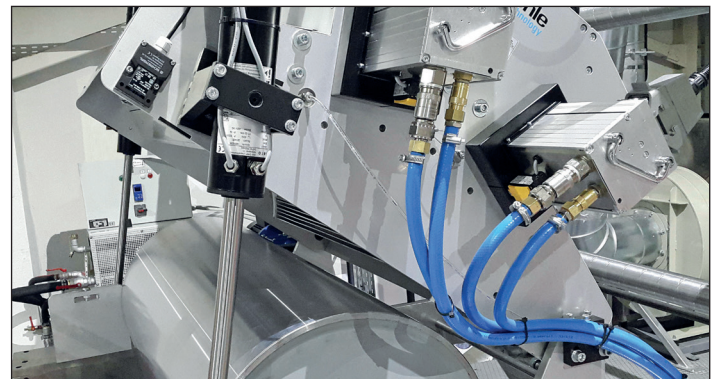

Advantage: lower temperature load on the substrate

## In house manufacturing of Electronic Power Supplies (EPS)

To supply and control the UV units, electronic power supplies made by Hönle are used. Compared to conventional ballasts, the UV output can be increased by 10% while the electrical power stays the same. With improved reignition, the usable life of the UV lamps can be extended. The maximum power output of the electronic power supplies ranges from 9.2 kW up to 40 kW.



Electronic Power Supplies (EPS)

## Individual UV lamps

The core of all UV systems is the lamp. As a systems manufacturer, Hönle distributes lamps developed and produced in its own manufacturing facility. This assures that the lamps supplied are designed and adjusted as required for the specified application. Lamps are available in arc lengths from 50 mm up to 3000 mm and power outputs of up to 60 kW. As well as all standard spectra, we also develop customer specified spectra for special applications.

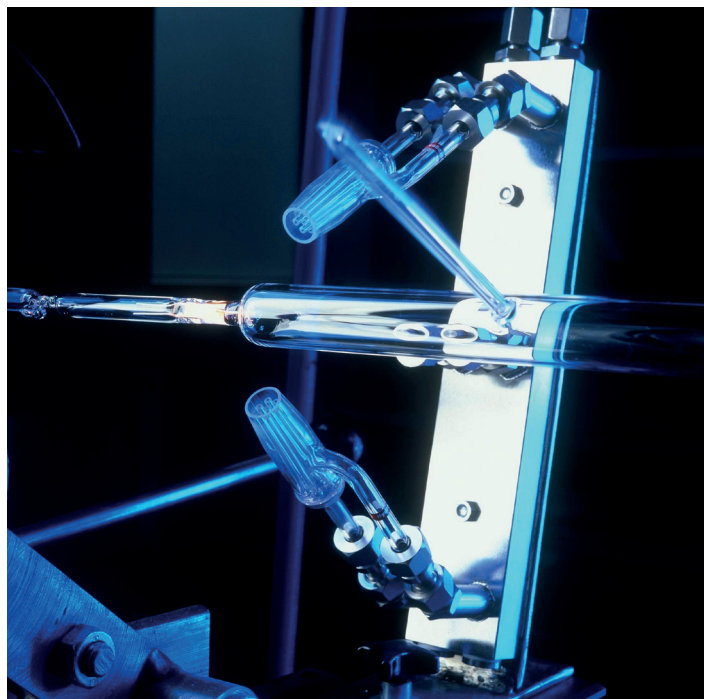

UV lamp in production process at Hönle



Head Office

Dr. Hönle AG UV Technology, Nicolaus-Otto-Str. 2, 82205 Gilching, Germany  
Phone: +49 8105 2083-0, Fax: +49 8105 2083-148. [www.hoenle.de](http://www.hoenle.de)

Operating parameters depend on production characteristics and may differ from the foregoing information.  
We reserve the right to modify technical data. © Copyright Dr. Hönle AG. Updated 05/22

